

# Cylinder and System Flushing

## For Teledyne Isco Syringe Pumps

### Overview

In order to maintain your syringe pumps at optimal performance, avoid damage to the cylinder, and lengthen seal life, it is important to keep the system free of corrosive or abrasive residue, and prevent cross-contamination between pumped fluids.

Depending on your pump model, there are standard and optional methods for flushing the system.

### Flushing Pumps With External Transducers

When changing pumped liquids in the Model 65D or other models with external transducers, flush the pump to prevent cross-contamination or difficulties with incompatible fluids.

In comparison to other D-Series pumps, those with external transducers have a greater dead volume space due to transducer and tubing differences. This dead volume space increases the possibility of residual liquid being held in the pump. Also, the external transducer may retain residual liquid. Dead volumes for D-Series pump models are listed in Table 1 in technical bulletin [TB15 Metering Pumps](#).

To flush the pump, remove the transducer and its tubing from the top of the pump.

#### CAUTION

Never immerse the transducer in solvent.

Using nitrogen, blow out any liquid that remains inside the cylinder, transducer port, and tubing.

#### WARNING

**Liquids expelled by compressed gasses may cause injury. Wear eye protection. Certain liquids also may require other personal protective equipment. Refer to the applicable Material Safety Data Sheet (MSDS) for more information.**

### Flushing the Cylinder

After cylinder/seal maintenance or during liquid solvent change, the pump cylinder should be flushed to remove possible residue.

The way in which the cylinder is flushed will depend on your pumping system and whether you are pumping a liquefied gas such as CO<sub>2</sub> or a liquid such as methanol.

### Gas Solvent Changeover

This procedure is used when changing from one gaseous solvent to another.



1. Close the valve on the fluid supply tank so that no solvent is supplied to the system.
2. Turn the controller ON.
3. Open the pump outlet valve. If there was any pressure in the system, wait until all the pressure bleeds off.
4. Change the solvent tank.
5. Close the pump outlet valve.
6. Open the valve on the tank to repressurize the system.
7. Refill the pump, if necessary.

### Liquid Solvent Changeover and Flushing

This procedure is typically used for systems when changing from one liquid solvent to another.

#### Note

If high ionic strength aqueous reagent solutions are allowed to remain in the pump, solid residues may be formed, which will scratch the seals and the polished inner surface of the cylinder of the pump. These scratches allow leakage, which decreases flow rate.

1. Press .
2. Press . You will be asked to designate which pump if more than one is present.
3. Press a softkey to run the desired pump.
4. Run the pump until the message "CYLINDER EMPTY" is displayed.
5. Place the pump inlet line in a flask containing a compatible solvent or a detergent solution.
6. Press .
7. You will be asked to designate the pump to refill if more than one is present. Press a softkey to refill the pump.
8. Fill the pump and repeat this procedure several times.
9. Place the pump inlet line in a flask containing distilled water or appropriate solvent. Fill the pump once more and then run it until empty. You are now ready to fill the pump with the new liquid solvent.

**☑ Note**

Do not store the pump for long periods of time with buffer solutions in the cylinder that contain dissolved salts or are corrosive. The pump should be stored with methanol or isopropanol (at least partially fill the cylinder with either solvent and then run the piston all of the way up) when it is not being used.

**Nitrogen Purge**

A thin film of liquid wets the inside of the cylinder each time the piston travels up the cylinder. Salt solutions, brines, and buffer solutions liquids drying in the air can leave behind residues that can damage the surfaces of the cylinder and seals.

All pumps that **do not have a wash gland** (see next section) are equipped with a purge connector tube near the top of the pump body. The purge connector enables the pump cylinder beneath the piston to be purged with nitrogen, which can increase the useful cylinder life by flushing residue from the system. Figure 1 shows a typical connection to the purge tube on the back of the pump.

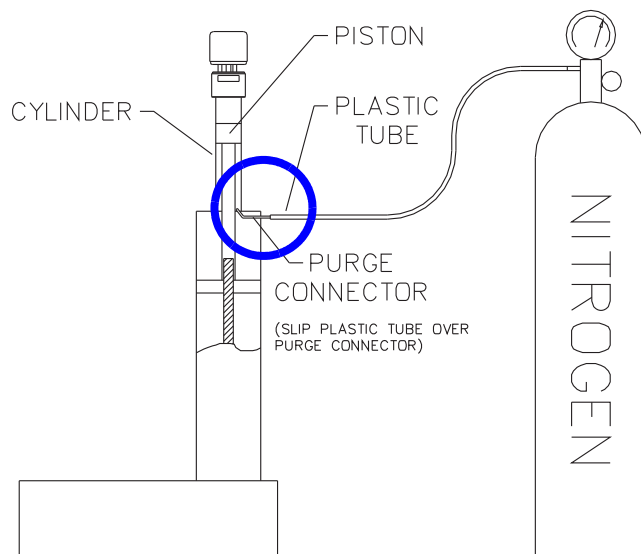

**Figure 1: Purge connector installation**

1. Attach the gas supply by slipping the plastic tube over the end of the purge connector (see close-up view of connector at right).
2. Regulate the nitrogen supply to slightly above atmospheric pressure.

**Figure 2: Close-up of nitrogen purge tube**

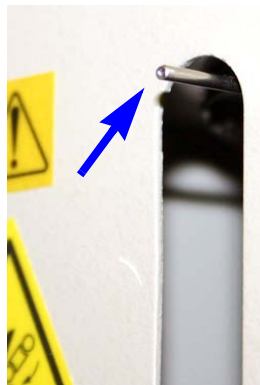
**Wash Gland**

A thin film of liquid wets the inside of the cylinder each time the piston travels up the cylinder. The lowest flow rates are conducive to the most abrasive or corrosive pumping environments, as the deposited film remains on the inside of the cylinder wall for the longest time.

The Model 1000D syringe pump is equipped for cylinder washing, with two  $\frac{1}{8}$ " tubes on the back to feed and drain the wash gland, as shown in Figure 3 on the following page.

A small pump can be used to deliver the wash fluid through one of the two tubes to rinse the cylinder and seals. The second tube drains the wash fluid to waste or recirculates it. If the system is configured to recirculate the wash fluid, ensure that you change the wash fluid at regular intervals.

Select a wash fluid that will best flush the cylinder of any residue left by the pumped fluid, yet will not damage the seals.

**⚠ CAUTION**

The pressure in the wash gland and line should NEVER exceed the system pressure. A wash pressure greater than the system pressure may force wash liquid past the pump's main seals and contaminate the delivery fluid.

**☑ Note**

If the primary pump seal fails, the pressure of the delivery fluid will be exerted on the secondary (wash gland) seal. During operation, the wash gland outlet should always be uncapped and routed for either recirculation or drainage.

**☑ Note**

Detailed information about pumping salt solutions and brines is available in technical bulletin [TB04 Pumping Salt Solutions and Brines](#).

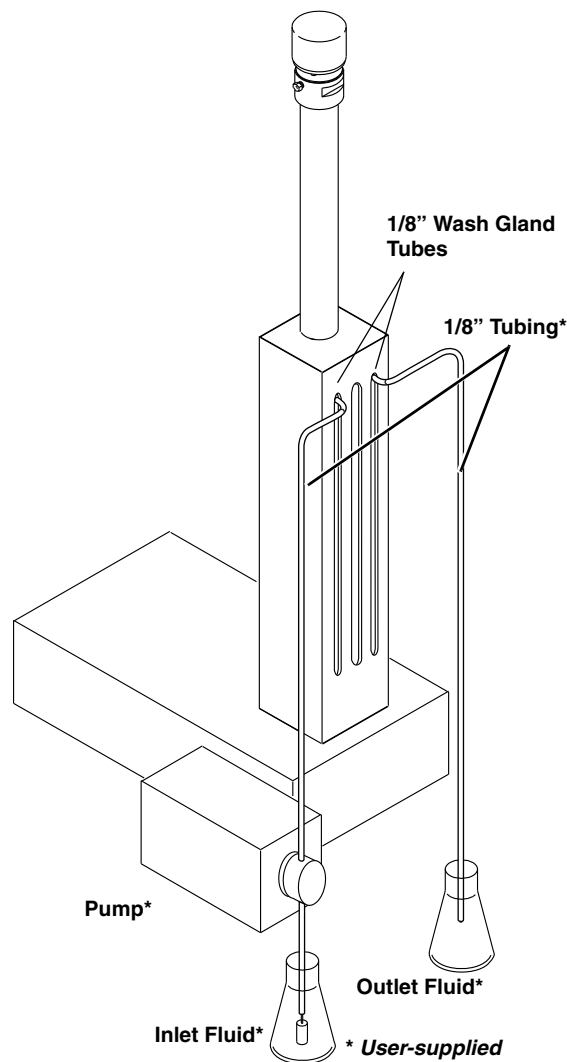
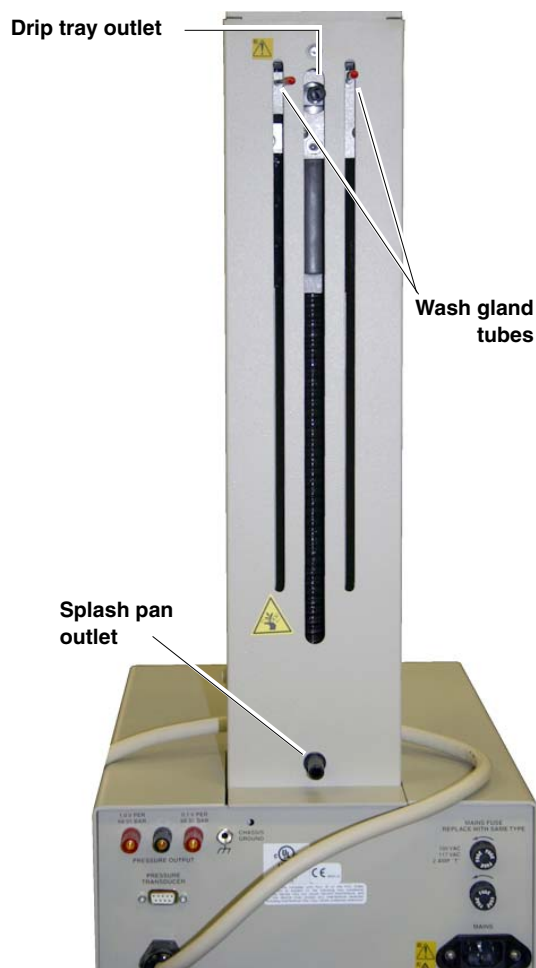

**Figure 3: Drain tube installation and wash gland connection (Model 1000D)**

**Teledyne Isco**

P.O. Box 82531, Lincoln, Nebraska, 68501 USA  
Toll-free: (800) 775-2965 • Phone: (402) 464-0231 • Fax: (402) 465-3001  
E-mail: [IscoService@teledyne.com](mailto:IscoService@teledyne.com)

Teledyne Isco is continually improving its products and reserves the right to change product specifications, replacement parts, schematics, and instructions without notice.

